

Distance Sensor M27

Laser Sensor bandwidth 37 kHz
Measurement range
0,5 ... 200 mm

Triangulation analog



M27 / 1,5



M27 / 100

- compact sensor head
separate electronic system
- measurement independent
from object: shiny, dark
- for fast measurements as for
example:
Vibration measurement
- easy set up of measurement
frequency and reaction time

• Measuring
• Controlling
• Monitoring

Sensor head Type / 0,5
weight 250 g, cable length 2 m

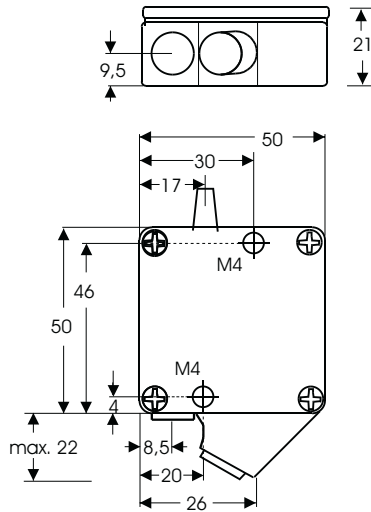

Sensor head M27L / 1,5
weight 290 g, cable length 2 m

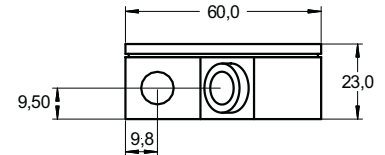

Sensor head Type / 2 / 4 / 10 / 20
weight 240 g, cable length 2 m

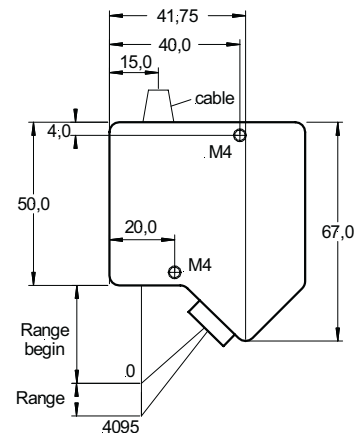
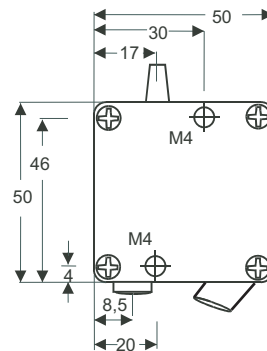

Sensor head Type / 100 / 200
weight 400 g, cable length 2 m

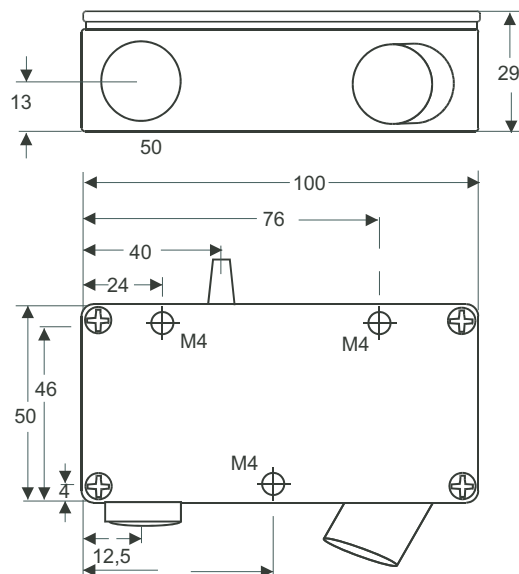

Laser Sensor M27

Fast capturing for example: vibration measurement

Sensor	M27L/ 0,5	M27L/ 1,5	M27L/ 2	M27L/ 4	M27L/ 10	M27L/ 20	M27L/ 50	M27L/ 100	M27L/ 200
Range [mm]	0,5	1,5	2	4	10	20	50	100	200
Range begin [mm]	23,75	32,75	23	22	40	55	95	170	240
Linearity* [mm]	0,001	0,004	0,004	0,008	0,02	0,04	0,1	0,2	0,4
Resolution* [mm]	0,0015	0,0045	0,006	0,012	0,03	0,06	0,2	0,5	1,0
Resolution** [mm]	0,0075	0,0225	0,03	0,06	0,15	0,3	0,8	2,0	4,0
Light spot diameter [mm]	0,1	0,1	0,2	0,3	0,6	0,9	1,5	1,5	2,0
Laser protection class	2	2	2	2	2	2	2	3R	3R

Light source Laser, 670 nm, red visible

Sampling frequency 136 kHz

Distance output ± 10 V (optional 0 ... 10 V / 0 ... 5 V / ± 5 V)

RS 232 / 4 ... 20 mA (optional 0 ... 20 mA)

Impedance approx. 0 Ohm (10 mA max.)

Angle error with 30° of inclination (A-axis): approx. 0,5% on white surface

Reaction time 27 ... 400 μ s

Bandwidth 2,5 ... 37 kHz (-3 dB)

Temperature drift 0,02% / K of range

Intensity output 0 ... 10 V

MIN +24 V / 10 mA when lower than MIN, LED yellow

OK +24 V / 10 mA when higher than MIN and lower than MAX, LED green

MAX +24 V / 10 mA when higher than MAX, LED orange

Error output +24 V / 10 mA, LED red

Switching hysteresis approx. 0,5% of range

Ambient light 20.000 Lux

Operation time 50.000 h for Laser diode

Isolation voltage 200 VDC, 0V against case

max. Vibration 5 g up to 1 kHz (sensor head, 20 g optional)

Operation temperature 0° ... +50°C

Storage temperature -20° ... +70°C

Humidity up to 90% RH

Protection class Sensor: IP 64, Electronic system: IP 40

Supply +24 VDC / 200 mA (10 ... 30 V)

* Measurement on object color white - frequency range 2,5 kHz

** Measurement on object color white - frequency range 37 kHz

Delivery:

- Sensor with connection cable 2 m
- Electronic unit
- 25 pin D-Sub-connector for output, soldering version

Options:

- Special cable length
- Sensor head with integrated protection glass
- Sensor head vibration resistant

Accessories:

- Thickness measurement system
- High laser power
- Protection casing
- Interference filter
- Connection cable for RS 232
- Extension cable sensor head 2 m
- Power supply for integration
- Power supply, EU
- Digital display (display in mm)
- More accessories on request

Special types on request

Electronic unit M27

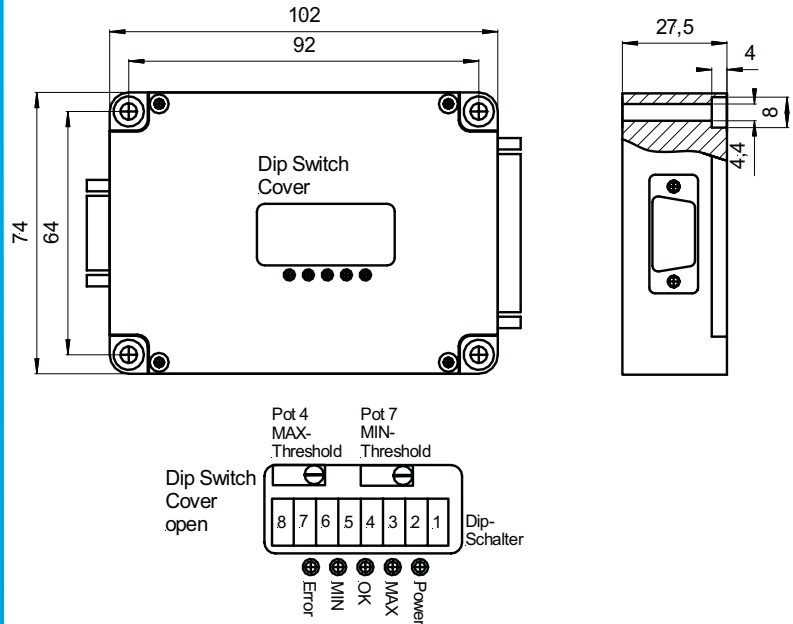

Pin assignment 25 pin SUB-D connector:

Pin	Function
1	Distance output ± 10 V
2	Error +24 V / 10 mA
3	Laser OFF, 0V
4	TXD
5	Range OK, +24 V / 10 mA
6	4 ... 20 mA
7	RXD
8	0V supply
14	Analog GND
16	MAX, +24 V / 10 mA
17	Input Sensor 2
18	RTS
19	MIN, +24 V / 10 mA
20	Intensity 0 ... 10 V
21	+24 V supply

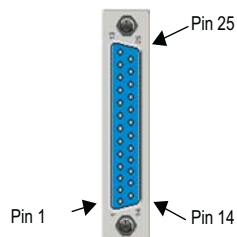

Dip switch settings:

SW1	Function
on	RS 232 Software Trigger with RXD
off	Stop with RTS

SW2	Function
on	RS 232 Baud rate = 38,4 kBaud
off	RS 232 Baud rate = 115,2 kBaud

SW3 unconnected

SW4	SW5	SW6	F/kHz	T/ μ s
on	on	on	37	27
off	on	on	30	33
on	off	on	25	40
off	off	on	20	50
on	on	off	15	67
off	on	off	10	100
on	off	off	5	200
off	off	off	2,5	400

SW7	SW8	Function
on	on	Normal-Laser off when I/O = GND
off	on	Trigger with I/O = GND
on	off	Sensor = Master
off	off	Sensor = Slave

Default setting 37 kHz